



Equipments Cathodic Protection





Equipments

Cathodic Protection



SOMMAIRE

- IRON / SILICON ANODES
- MAGNESIUM ANODES
- MAGNESIUM RIBBON
- COKE DUST – BACKFILL
- AIR COOLED TRANSFORMER RECTIFIER
- OIL COOLED TRANSFORMER RECTIFIER
- PORTABLE REFERENCE ELECTRODE
- EXPLOSION-PROOF LINE SPARK GAP
- U1000 R2V CABLE
- INDUSTRIAL FLEXIBLE CABLE
- Y - SHAPED JUNCTION BOX WITH RESIN FILLING
- JUNCTION BOX WITH RESIN FILLING
- CLAW CONNECTORS
- C-SHAPED BRANCHING CONNECTOR
- SLEEVES WITH INNER STOP
- TUBULAR CABLE LUGS
- ELECTRICAL INSTALLATION TAPE
- HANDY CAPS
- JANOFLEX
- WARNING MESH



Société Internationale de Produits et Services Industriels

102 rue J.-B. Charcot

92400 Courbevoie - France

☎ : (33) 01 47 68 75 00

✉ : ipsi@ipsifrance.com

☎ : (33) 01 47 89 99 39

🌐 : www.ipsifrance.com

IRON / SILICON ANODES

Fe/Si anodes are designed for efficient corrosion protection of steel structures and pipelines using the impressed current method. They are made of a cast steel alloy having a high silicon content, one of the anode materials most widely used by corrosion specialists to protect steel in various situations.

Specifications

Composition		
Fe/Si anodes exhibit the following typical analyses :		
	Fe/Si	Fe/Si/Cr
Silicon	14,25 to 15,25 %	14,25 to 15,25 %
Manganese	Max. 1,0 %	Max. 1,0 %
Carbon	Max. 1,0 %	Max. 1,4 %
Chromium	–	4,0 to 5,0 %
Iron	Balance	Balance
Typical consumption rates of Ferroline anodes		
Environment	Current density	Consumption rate
	A/m ²	kg/A an
Fresh water	10	0,11
Seawater	15	0,31
	50	0,47
200F seawater	10	0,41
Underground seawater / sand	8	0,68
Carbonaceous fill	15	0,10



Anode types Fe/Si anodes are cast to several sizes and shapes to suit a variety of requirements. The drawings below show the available range. Anodes with different shapes and weights and with special head configurations can also be manufactured upon request.

Single head anode

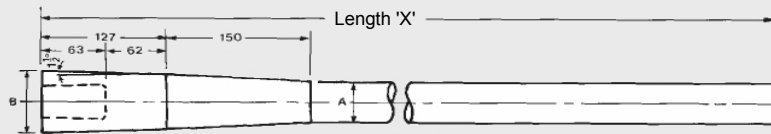

Anode size	Anode dia. 'A' mm (inches)	Head dia. 'B' mm (inches)	Overall length 'X' mm (inches)	Weight kg
3"	76 (3)	100 (4)	910 (36)	32
	76 (3)	100 (4)	1220 (48)	33
	76 (3)	100 (4)	1525 (60)	50
2½"	65 (2½)	90 (3½)	910 (36)	24
	65 (2½)	90 (3½)	1220 (48)	31
	65 (2½)	90 (3½)	1525 (60)	38
2"	50 (2)	74 (3)	910 (36)	15
	50 (2)	74 (3)	1225 (48)	19
	50 (2)	74 (3)	1525 (60)	23
1½"	39 (1½)	64 (2½)	910 (36)	10
	39 (1½)	64 (2½)	1220 (48)	13
	37 (1½)	64 (2½)	1525 (60)	15
1"	30 (1)	40 (1½)	300 (12)	2

The weights and dimensions shown in the table are nominal values.

Dual head anode

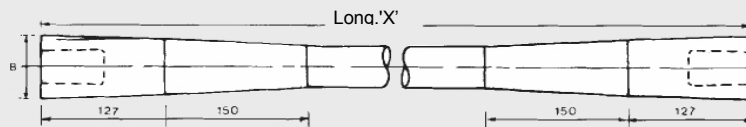

Société Internationale de Produits et Services Industriels

102 rue J.-B. Charcot

92400 Courbevoie - France

☎ : (33) 01 47 68 75 00

✉ : ipsi@ipsifrance.com

☎ : (33) 01 47 89 99 39

🌐 : www.ipsifrance.com

Specification

IPSI can supply a wide range of Fe/Si and Fe/Si/Cr tubular anodes. Tubular anodes are connected by means of a central cable, which in some applications allows avoiding end effects and ensuring a more uniform consumption.

Anode cable Connection

Four cable connection modes are possible, the caulked joint version being standard. If necessary, special models can be manufactured. The standard formats are illustrated below.

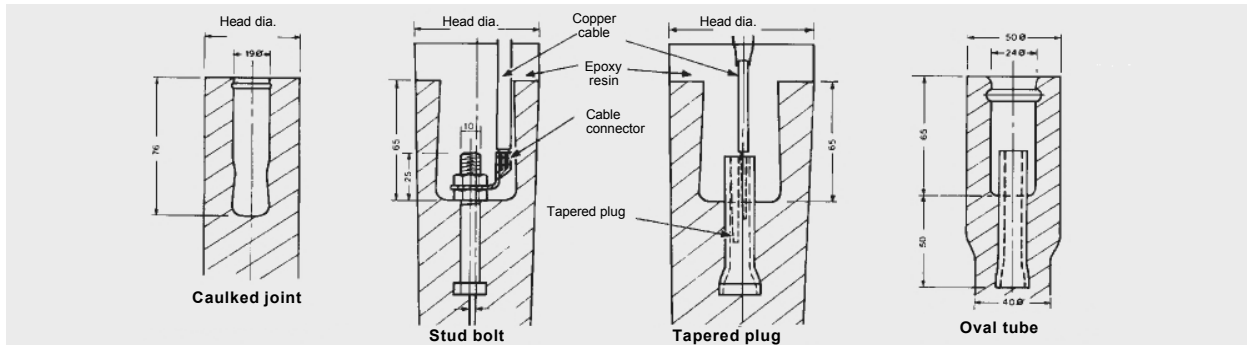

Anode caps

Anode caps can be factory-mounted onto the wired anodes. These caps are intended to counter the so-called end effect when a single-sided anode connection is specified. They feature a polymer protective coating that can withstand corrosive environmental conditions, including aggression by chlorine and sulfates. They are made of cross-linked polyethylene and they are shrink-mounted onto the anode end. Their dielectric strength is 10 kV per mm.



Cables

Fe/Si anodes can also be supplied as pre-wired assemblies with cables connected to the cast part and overfilled with resin. Different cable types and gages can be supplied. The standard versions are fitted with 6, 10, 16, and 25 mm² gage cables to accommodate all types of environments. As standard, the cables have an XLPE/PVC insulation. The data sheets of the cables are available upon request.

Canistered anodes

Fe/Si anodes can also be supplied encapsulated in galvanized steel jackets complete with backfill. Details are available upon request.



Société Internationale de Produits et Services Industriels

102 rue J.-B. Charcot
92400 Courbevoie - France

☎ : (33) 01 47 68 75 00
✉ : ipsi@ipsifrance.com

☎ : (33) 01 47 89 99 39
🌐 : www.ipsifrance.com

MAGNESIUM ANODES

Applications of magnesium anodes in cathodic protection

Among the materials used to manufacture sacrificial anodes, magnesium has the highest bias voltage and it is the material more often used for onshore installations (in more resistive electrolytes), where the use of zinc and aluminum would not be economic. The most current applications are as follows :



Temporary CP systems

- Temporary protection of onshore and other pipelines during the laying phase and before the activation of the impressed current system.
- Descaling of tanks.
- External protection of ship hulls staying in fresh or brackish water.

Permanent CP systems

- Onshore pipelines.
- Buried storage tanks, oil product tanks in high risk areas.
- Short length pipelines with water course crossings.
- Private or commercial supply lines.
- Outer surfaces of caissons in fresh or brackish water.
- Inner surfaces of water tanks and treating plants.

Available alloys

Magnesium anodes are available with several different chemical compositions but two basic generic types having output voltages of approx. 1.55 and 1.75 V (as referred to a copper/copper sulfate reference electrode).

Chemical composition	Output (Cu/CuSO ₄)	
	LOW POTENTIAL 1.55 V	HIGH POTENTIAL 1.75 V
Aluminum	5,3-6,7%	Max 0,01%
Zinc (Zn)	2,5-3,5%	-
Copper (Cu)	Max. 0,08%	Max 0,02%
Silicon (Si)	Max 0,3%	Max 0,05%
Manganese (Mn)	Max 0,25%	0,5-1,3%
Iron (Fe)	Max 0,005%	Max 0,03%
Lead (Pb)	Max 0,03%	-
Other impurities, each	-	Max 0,05%
Total other impurities	-	Max 0,30%
Magnesium	Balance	Balance
Capacity (Ah/kg)	1230	1230

Anode shapes

Very high quality anodes can be supplied in circular (for vertical casting) or D-shaped version (for horizontal casting).

Fig. 1
D-shaped anode



Fig. 2
Circular anode

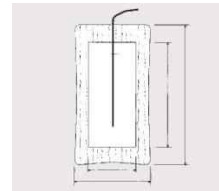

Pre-backfilled anodes

The anodes used for pipelines, cisterns and buried tanks are usually supplied pre-conditioned in a cotton bag with a backfill wrap. The environment created by the backfill helps generating a more uniform output current and rate of solution and it lowers the electrolyte's resistance. The anodes used in low resistivity soils can be supplied bare.



Société Internationale de Produits et Services Industriels

102 rue J.-B. Charcot
92400 Courbevoie - France

☎ : (33) 01 47 68 75 00
✉ : ipsi@ipsifrance.com

☎ : (33) 01 47 89 99 39
🌐 : www.ipsifrance.com

Backfill composition

Gypsum powder	75%
Bentonite	20%
Sodium sulfate	5%

Weight and dimensions

All anodes are cast only in accordance with the latest manufacturing drawings. The dimensions and weights of the cast parts are nominal values subject to foundry tolerances.

The dimensions and weights of conditioned anodes are subject to manufacturing tolerances and the values shown may vary because of packing during transport and handling.



Circular magnesium anodes, bare

Ref.	1,55 V			1,75 V		
	Net weight	Dia.	Length	Net weight	Dia.	Length
	kg	mm	mm	kg	mm	mm
C036	3,6	114	193	3,6	114	202
C041	4,1	114	220	4,1	114	230
C050	5,0	114	268	5,0	114	277
C077	7,7	114	412	7,7	114	431
C100	10	114	536	10	114	560
C145	14,5	146	472	14,5	146	494
C227	22,7	178	497	22,7	178	520
C273	27,3	178	598	27,3	178	625
C274	27,3	114	1462	27,3	114	1528

D-shaped magnesium anodes, bare

Ref.	Net weight	1,55 V et 1,75 V		Length
		Dimension A (Fig. 1)	Dimension B (Fig. 2)	
	kg	mm	mm	mm
D023	2,3	70	64,5	305
D032	3,2	70	64,5	430
D041	4,1	70	64,5	550
D0635	6,35	70	64,5	850
D077	7,7	90	83	650

Pre-backfilled circular magnesium anodes

Ref.	Gross weight	Overall Diameter	Overall Length
	kg	mm	mm
C036P	7	150	425
C041P	9	150	480
C050P	11	150	535
C077P	15	150	580
C100P	22	165	660
C145P	30	190	840
C227P	45	255	760
C273P	50	255	915
C274P	50	165	1880

Pre-backfilled D-shaped magnesium anodes

Ref.	Gross weight	Overall Diameter	Overall Length
	kg	mm	mm
D023P	5	150	500
D032P	7	150	580
D041P	9	150	700
D0635P	14	150	1040
D077P	16	200	1000

Cable

The buyer may specify the size and type of the connecting cable. We recommend 3 meters of KATHODICA™ red/red cathodic protection cable with 6-mm² gage multi-strand single-core copper conductors with XLPE insulation and PVC jacket, 600/1000 V quality per IEC 502/ 83 & BS 5467, which is adequate for most applications.



Société Internationale de Produits et Services Industriels

102 rue J.-B. Charcot
92400 Courbevoie - France
☎ : (33) 01 47 68 75 00
✉ : ipsi@ipsifrance.com

📞 : (33) 01 47 89 99 39
🌐 : www.ipsifrance.com

MAGNESIUM RIBBON



Sometimes used instead of service anodes, the magnesium ribbon is extruded from a 1.75-V potential alloy and it is usually supplied in full coils (305 m). Shorter lengths are available upon request.

Chemical composition

Aluminum (Al)	Max. 0.01%
Copper (Cu)	Max. 0.02%
Manganese (Mn)	0.5-1.3%
Iron (Fe)	Max. 0.03%
Niobium (Ni)	Max. 0.001%
Other impurities, each	Max. 0.05%
Magnesium	Balance

Capacity (Ah/kg)	1230
Nominal dimensions (mm)	19 x 9.5
Dia. 3.4 mm core	Steel rod
Nominal weight	0.361 kg/m (0.242 lb)

Output current per m of length, approx.) :

Seawater (25 ohm.cm)	2.5 A
Soil (5,000 ohm.cm)	12 mA
Fresh water (15,000 ohm.cm)	4 mA



Société Internationale de Produits et services Industriels

102 rue J.-B. Charcot
92400 Courbevoie - France
☎ : (33) 01 47 68 75 00
✉ : ipsi@ipsifrance.com

☎ : (33) 01 47 89 99 39
🌐 : www.ipsifrance.com

COKE DUST - BACKFILL

The performance of cathodic protection anodes can be enhanced by carefully selecting the backfill that will provide a low soil resistivity at a minimum cost.

Defined for performance :

The key characteristics to define a suitable backfill are :

- Bulk density
- Resistivity
- Porosity
- Flowability
- Purity

Benefits

- Low bulk density
- Low resistivity
- High porosity
- Good flowability
- Purity - low sulfide content for minimum corrosion risks

Specifications

Grain size	0-10 mm
Humidity	12-15%
Ash/dry mass	11 – 14.5%
Volatiles/dry mass	1.8 – 2.1%
Sulfur/dry mass	0,6% - 0.7%



Packaging

The backfill is supplied in a crate containing 40 bags of 25 kg each, i.e. 1 ton.

Availability

Large stock insuring a quick response to our buyers' delivery requirements.



Société Internationale de Produits et services Industriels

102 rue J.-B. Charcot
92400 Courbevoie - France
☎ : (33) 01 47 68 75 00
✉ : ipsi@ipsifrance.com

☎ : (33) 01 47 89 99 39
🌐 : www.ipsifrance.com

AIR-COOLED TRANSFORMER RECTIFIER



Single-phase power supply 230 V AC - 50 Hz
Three-phase power supply 400 V AC – 50 Hz
Output voltage range from 12 to 150 V DC
Output current range from 1 to 250 A DC
Operating ambient temperature: –20 to +55 °C

Control mode :

- Manual (variable autotransformer)
- Semi-automatic (mixed bridge)
- Automatic with servo control via AutoPC

Cabinet types :

- 1.5 or 2-mm thick sheet steel with structured epoxy paint finish RAL 7032 - IP55 / IK10 (other upon request)
- Polyester RAL 7035 - IP66 / IK10, suited for corrosive environments
- Rack-mounted in a 2-mm thick sheet steel bay with structured epoxy paint finish RAL 7032 - IP55 / IK10 (other upon request)



**Automatic
transformer rectifier**



**Semi-automatic
transformer rectifier**



Société Internationale de Produits et services Industriels

102 rue J.-B. Charcot
92400 Courbevoie - France
☎ : (33) 01 47 68 75 00
✉ : ipsi@ipsifrance.com

☎ : (33) 01 47 89 99 39
🌐 : www.ipsifrance.com

SELECTION GUIDE

AIR-COOLED TRANSFORMER RECTIFIER

Description		Comments				
Input	Power supply	Single-phase 230 V				
		Three-phase 380-400 V				
	Input protection	Yes		No		
Cooling	Natural or forced convection	Natural ventilation				
		Blower + thermostat				
Control mode	Variable autotransformer	Yes		No		
	Semi-automatic (diode-SCR mixed bridge)	Yes		No		
	Automatic (AUTO PC)	Yes		No		
	4-20 mA remote	Yes		No		
Output	Voltage	Value:			Volt	
	Current	Value:			Amp	
	Output protections	Yes		No		
Output and measuring terminal	Positive output terminal	Quantity:		Cable size:		
	Negative output terminal	Quantity:		Cable size:		
	Potential terminal: electrode	Quantity:		Cable size:		
	Potential terminal: structure	Quantity:		Cable size:		
Display and measurement	Voltage	Analog meter	Yes		No	
		Digital meter	Yes		No	
	Current	Analog meter	Yes		No	
		Digital meter	Yes		No	
	Potential	Analog meter	Yes		No	
		If yes, value:				Volt
		Digital meter	Yes		No	
		On/Off switch	Yes		No	
	Location of measuring devices	On cabinet door	Yes		No	
		Inside cabinet	Yes		No	
	Measuring jack for 4 mm safety plug	Voltage	Yes		No	
		Current	Yes		No	
Potential		Yes		No		
Socket on terminal	Output terminal	Yes		No		
	Potential	Yes		No		
Cabinet	Polyester	Paint finish RAL 7035 (grey)	Yes		No	
		Paint finish RAL 7035 (grey)	Yes		No	
	Steel	Paint finish RAL 7032 (beige)	Yes		No	
		Wall-mounted	Yes		No	
	Installation	On pedestal	Yes		No	



Société Internationale de Produits et services Industriels

102 rue J.-B. Charcot
92400 Courbevoie - France
☎ : (33) 01 47 68 75 00
✉ : ipsi@ipsifrance.com

☎ : (33) 01 47 89 99 39
🌐 : www.ipsifrance.com

Description		Comments				
Options	4-20 mA measuring converter	Voltage	Yes		No	
		Current	Yes		No	
		Potential	Yes		No	
	Protection time counter	CHI - Current	Yes		No	
		CHE - Potential	Yes		No	
	Portable periodic switch CR100		Yes		No	
	Non-synchronized periodic switch		Yes		No	
	Green Power On indicator lamp on cabinet door		Yes		No	
	Red CP Fault indicator lamp with elapsed time meter		Yes		No	
			Yes		No	
	Power outlet + differential circuit breaker		Yes		No	
	Cabinet interior lighting		Yes		No	
Heating element + hygostat (anti-condensation)		Yes		No		

Other and Comments:

Number of transformer rectifiers:	
Your ref.:	
Requested answer date:	
Company name:	
Requesting person:	
Address:	
Telephone:	
Fax:	



Société Internationale de Produits et services Industriels
 102 rue J.-B. Charcot
 92400 Courbevoie - France

☎ : (33) 01 47 68 75 00
 ✉ : ipsi@ipsifrance.com

☎ : (33) 01 47 89 99 39
 🌐 : www.ipsifrance.com

OIL-COOLED TRANSFORMER RECTIFIER



Single-phase power supply 230 V AC - 50 Hz
Three-phase power supply 400 V AC – 50 Hz
Output voltage range from 50 to 150 V DC
Output current range from 50 to 250 A DC
Oil cooling
Operating ambient temperature: –5 to +55 °C

Control mode :

- Manual (variable autotransformer)
- Semi-automatic (mixed bridge)
- Automatic with servo control via AutoPC

Cabinet type :

1.5 or 2-mm thick sheet steel waterproof cabinet with structured epoxy paint finish RAL 7032 - IP55 / IK10 (other upon request).



Société Internationale de Produits et services Industriels

102 rue J.-B. Charcot
92400 Courbevoie - France
☎ : (33) 01 47 68 75 00
✉ : ipsi@ipsifrance.com

☎ : (33) 01 47 89 99 39
🌐 : www.ipsifrance.com

SELECTION GUIDE

OIL-COOLED TRANSFORMER RECTIFIER

Description		Comments			
Input	Power supply	Single-phase 230 V			
		Three-phase 380-400 V			
	Input protection	Yes		No	
Control mode	Variable autotransformer	Yes		No	
	Semi-automatic (diode-SCR mixed bridge)	Yes		No	
	Automatic (AUTO PC)	Yes		No	
	4-20 mA remote	Yes		No	
Output	Voltage	Value:		Volt	
	Current	Value:		Amp	
	Output protections	Yes		No	
Output and measuring terminal	Output terminal positive	Quantity :	Cable size :		
	Output terminal negative	Quantity :	Cable size :		
	Potential terminal: electrode	Quantity :	Cable size :		
	Potential terminal: structure	Quantity :	Cable size :		
Display and measurement	Voltage	Analog meter	Yes		No
		Digital meter	Yes		No
	Current	Analog meter	Yes		No
		Digital meter	Yes		No
	Potential	Analog meter	Yes		No
		Digital meter	Yes		No
		On/Off switch	Yes		No
	Location of measuring devices	On cabinet door	Yes		No
		Inside cabinet	Yes		No
	Measuring jack for 4 mm safety plug	Voltage	Yes		No
		Current	Yes		No
		Potential	Yes		No
	Socket on terminal	Output terminal	Yes		No
Potential		Yes		No	
Cabinet	Steel	Paint finish RAL 7032 (beige)	Standard		



Description		Comments			
Options	4-20 mA measuring converter	Voltage	Yes		No
		Current	Yes		No
		Potential	Yes		No
	Protection time counter	CHI - Current	Yes		No
		CHE - Potential	Yes		No
	Portable periodic switch CR100		Yes		No
	Non-synchronized periodic switch		Yes		No
	Green Power On indicator lamp on cabinet door		Yes		No
	Red CP Fault indicator lamp with elapsed time meter		Yes		No
			Yes		No
	Power outlet + differential circuit breaker		Yes		No
	Cabinet interior lighting		Yes		No
Heating element + hygostat (anti-condensation)		Yes		No	

Other and Comments :

Number of transformer rectifiers:	
Your ref.:	
Requested answer date:	
Company name:	
Requesting person:	
Address:	
Telephone:	
Fax:	



PORTABLE REFERENCE ELECTRODE

General: Copper sulfate reference electrodes

The RE series of electrodes features three types of improvements over prior electrodes:

- ✓ a lexan tube
- ✓ a ceramic plug
- ✓ a sturdy upper cap with a high purity copper rod

Ceramic plugs have numerous advantages, including :

- ✓ The ceramic plug has a uniform and controlled porosity.
- ✓ The plug is characterized by fast wetting properties and the electrode may be used within a few minutes after packing, whereas wetting a wooden plug may require many hours.
- ✓ The plug is pretreated in order to guarantee a lower electrical resistance, which remains low as long as the plug is wetted by a saturated copper sulfate solution.
- ✓ A plug may dry completely and be re-wetted in a few minutes with an unchanged low resistance.
- ✓ Tests have shown that the plug needs not be covered to prevent it from drying when it is not in use. However, it is advisable to cover it. A protective cap is provided for that purpose.



Model RE5 electrode plug

Model RE5-C electrode plug



The bright orange color of the lexan tube was chosen in order to ensure that the electrode can be seen easily in grass and to help locating it when it is placed remotely or detached from the "pulling" wire. Some of its other advantages are as follows :

- ✓ The lexan tube used in the electrode models RE-5 and RE-5C is extruded in two colors, orange and transparent. The orange part is opaque and forms a sun shield, whereas the segment extending over the electrode length constitutes a visual inspection window which is used to observe the condition and the level of the copper sulfate solution. This window is essential in maintaining the electrode in good condition.
- ✓ The lexan tube is highly resistant to mechanical damage. It may be handled roughly, driven into soft ground, dropped and transported in a tool box without breaking.

The large-diameter (76 mm) flat porous plug allows a greater contact surface area. The flat plug provides a lower contact resistance than a rounded or corrugated plug when in direct contact with plane surfaces. Particularly useful on pavements, sidewalks, dry sand, frozen ground, etc.
Dimensions: dia. 76 mm x length 127 mm.
Dry weight: 454 g.



Model RE-3A electrode



Model RE-5 electrode

Standard flat porous plug for general use in soil, and in combination with a submersible adapter for use in water.
Dimensions: dia. 35 mm x length 153 mm.
Dry weight: 114 g.

Similar to model RE-5 but supplied with a tapered porous plug. For use in soft soils. Ensures a lower contact resistance. When driven into soft soil, the plug shape helps keeping the electrode "upright".
Dimensions: dia. 35 mm x length 172 mm.



Model RE-5C electrode



Société Internationale de Produits et services Industriels

102 rue J.-B. Charcot
92400 Courbevoie - France
☎ : (33) 01 47 68 75 00
✉ : ipsi@ipsifrance.com

☎ : (33) 01 47 89 99 39
🌐 : www.ipsifrance.com

EXPLOSION-PROOF LINE SPARK GAP



- For the indirect connection/earthing of installation elements normally insulated in operation in case of a lightning impulse.
- Model complying with potential balancing requirement for lightning protection per IEC 62305 and NF EN 62305 in areas at risk of explosion (zone 2).
- Complies with ATEX Directive 94/9/EC.
- Corrosion-resistant die-cast zinc housing with plastic cap and flexible cable connection.
- For shunting of insulating parts, etc. on pipe segments with anti-corrosion cathodic protection.
- Designed to withstand very high loads.

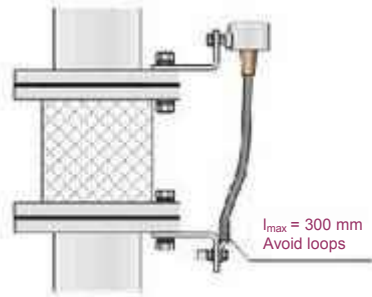

Mounting variant EXFS

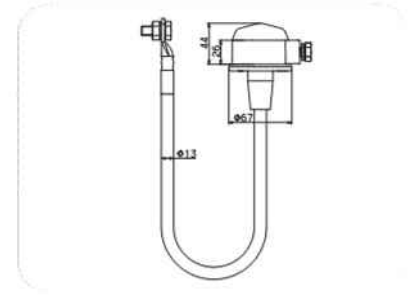

EXFS dimensions

		EXFS L200	
Lightning current (10/350) I_{imp}		50kA	
Lightning current withstand class per EN 50164-3		N	
Rated discharge current (8/20) I_n		100kA	
Rated permanent AC voltage (50 Hz) $U_{w/ac}$		300V	
Lightning impulse 100% flashover voltage U_{rimp}		$\leq 2,5kV$	
AC flashover voltage (50 Hz) U_{aw}		$\leq 1,2kV$	
Ex marking per EN 60079	Ex	II 3 G EEx nC II T4	
Operating temperature T_u	-20°C...+80°C	-20°C...+80°C	-20°C...+80°C
Protection index	IP54	IP54	IP54
Certification	ZELM 03 ATEX 3192X	ZELM 03 ATEX 3192X	ZELM 03 ATEX 3192X
Housing length	90mm	90mm	90mm
Housing diameter	63mm	63mm	63mm
Housing materials	Die-cast zinc, plastic		
Connecting cable	H01N2-D 25-mm ² gage with terminal and M10 screw & nut		
Cable length	100mm	200mm	300mm
Suited for flange sizes	20-130mm	120-130mm	220-130mm



Société Internationale de Produits et services Industriels

102 rue J.-B. Charcot
92400 Courbevoie - France
☎ : (33) 01 47 68 75 00
✉ : ipsi@ipsifrance.com

☎ : (33) 01 47 89 99 39
🌐 : www.ipsifrance.com

U1000 R2V CABLE

UNARMORED RIGID CABLES

NF C 32-321

Max. conductor temperature: 90 °C

1 - Core

Bare copper, solid $\leq 4 \text{ mm}^2$ class 1
Bare copper, stranded $> 6 \text{ mm}^2$ class 2

2 - Insulation

PR – cross-linked polyethylene

3 - Filler

4 - Outer jacket

PVC
Color : black

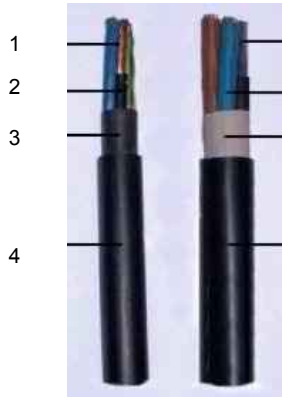

• Conductor identification

By colors: HD 308 S2

By numbers from 6 conductors upwards, with green/yellow conductor

• Cable jacket marking

NF USE - n G s - Factory no. - U 1000 R2V

• Bending radius

6 x outer diameter

This cable can be used for high power supply lines or for the interconnection of fixed stations.

It may be buried with extra mechanical protection.

U1000 R2V	Current carrying capacity (A)		Outer diameter (mm)		Bending radius (mm)	Copper weight (kg/km)	Approx. mass (kg/km)
	Buried	Free air	min.	max.			
1 x 1.5	34	24	-	6,4	38	14	48
1 x 2.5	46	33	-	6,8	41	23	60
1 x 4	59	45	-	7,2	43	37	78
1 x 6	74	58	-	8,2	49	55	102
1 x 10	101	80	-	9,2	55	92	146
1 x 16	128	107	-	10,5	63	147	207
1 x 25	148	142	-	12,5	75	230	305
1 x 35	179	175	-	13,5	80	322	400
1 x 50	214	212	-	15,0	90	460	525
1 x 70	264	270	-	17,0	100	644	735
2 x 1.5	34	24	8,8	10,5	63	28	129
2 x 2.5	46	33	9,6	11,5	66	46	162
2 x 4	59	45	10,5	13,0	72	74	209
2 x 6	74	58	11,5	14,0	84	110	282
2 x 10	101	80	13,0	16,0	87	184	397
2 x 16	128	107	15,0	18,5	111	294	553
2 x 25	162	142	18,4	22,0	120	460	840
3G 1.5	34	24	9,2	11,0	66	41	145
3G 2.5	46	33	10,0	12,0	72	69	186
3G 4	59	45	11,0	13,0	78	110	246
3G 6	74	58	12,0	15,0	66	166	336
3G 10	101	80	14,0	17,0	72	276	484
3G 16	128	107	16,0	19,5	78	442	689
3G 25	141	127	19,0	23,5	135	690	1095
3G 35	133	125	21,0	26,0	150	-	615
4G 1.5	29	22	9,8	11,5	69	55	169
4G 2.5	40	30	10,5	12,5	75	92	220
4G 4	51	40	12,0	14,0	84	147	294
4G 6	64	52	13,0	16,0	96	221	410
4G 10	88	71	15,5	18,5	111	368	600
4G 16	111	96	17,5	21,0	126	589	862



Société Internationale de Produits et services Industriels

102 rue J.-B. Charcot

92400 Courbevoie - France

☎ : (33) 01 47 68 75 00

✉ : ipsi@ipsifrance.com

☎ : (33) 01 47 89 99 39

🌐 : www.ipsifrance.com

INDUSTRIAL FLEXIBLE CABLES

H07RN-F TENAFLEX



Reference standards :

CENELEC HD 22.4
 NF C 32-102-4
 DIN VDE 0282-1 and VDE 0282-4
 BS 6007 and BS 6500
 Also complies with international specification
 IEC 60245-4-66









Nominal voltage :

Rated voltage : 450/750 volts
 (Utilization up to 1 kV is permitted in protected stationary installations and for powering motors, lifting devices and the like).

Use

Thanks to the characteristics of its insulating jacket and of its sheath, the TENAFLEX H07RN-F cable is particularly suited for the following conditions of use :

- Flexible cables with high tenacity and high resistance to mineral oils and greases: public work sites, quarries, wellbore installations, automotive industry, etc.
- Flexible cables for use in high ambient temperature conditions: hot countries, vicinity of furnaces, etc.
- Cables installed with short bending radii.
- Cables liable to function in low temperatures, up to -35°C in stationary uses (work site cables), and up to -10°C in lifting uses (e.g. baskets).

								
Very good	•		•	•	•	•	•	
Good		•						
Medium								•

Standard laying modes

According to installation conditions as defined in standard NF C 15-100 :

- Mobile duct.
- Wall mounting, on cable trays, in raceways.
- Buried with extra mechanical protection.
- May be used in rooms at risk of explosion (risk BE3), with adequate protection against mechanical risks; in this case, the current carrying capacity must be reduced by 15 %.

Specification/Construction

Copper conductive core

- Core flexibility : class 5
- Insulating jacket made of cross-linked elastomer.
- Black outer sheath made of cured nitrile-acrylic rubber.

These materials exhibit better characteristics than the respective EI4 and EM2 types specified in the standard, especially as regards the behavior at high and low temperatures. They are moreover lead-free.

Maximum allowable core temperature

- Permanent : 85°C^*
- Short circuit : 200°C .

* In the general characteristics tables shown on the following pages, the current carrying capacity and voltage drop values were calculated for a core temperature of 60°C , in compliance with European standards.

However, these cables may be used up to a core temperature of 85°C , in which case the current carrying capacity values are 20 % higher on average.



Société Internationale de Produits et services Industriels

102 rue J.-B. Charcot
 92400 Courbevoie - France
 ☎ : (33) 01 47 68 75 00
 ✉ : ipsi@ipsifrance.com

☎ : (33) 01 47 89 99 39
 🌐 : www.ipsifrance.com

General characteristics

Outer diameter approx.	Mass per km of cable approx.	Nominal gage	Current carrying capacity for cable laid on perforated trays	Voltage drop per ampere and per km (cos $\varphi = 0.8$)
mm	kg	mm ²	A	V
1 conductor				
6,5	50	1,5	19,5	21,5
7,0	65	2,5	27	13
8,0	90	4	36	8,1
8,5	115	6	48	5,45
10,0	175	10	63	3,2
12,0	255	16	85	2,05
14,0	370	25	112	1,4
16,0	490	35	138	1
18,0	670	50	168	0,72
20,5	900	70	213	0,54
2 conductors				
9,0	90	1	17	36,5
10,0	120	1,5	22	25
11,5	165	2,5	30	15
13,0	230	4	40	9,3
14,5	300	6	51	6,2
19,5	530	10	70	3,65
23,0	770	16	94	2,35
27,0	1100	25	119	1,55
3 conductors				
9,5	110	1	17	36,5
10,5	140	1,5	22	25
12,5	200	2,5	30	15
14,0	275	4	40	9,3
15,5	365	6	51	6,2
20,5	650	10	70	3,65
24,5	960	16	94	2,35
29,0	1400	25	119	1,55
32,5	1800	35	147	1,1
37,5	2450	50	179	0,81
42,0	3300	70	229	0,60
4 conductors				
10,5	135	1	14,5	31,5
11,5	175	1,5	18,5	21,5
13,5	250	2,5	25,0	13
15,5	345	4	34	8,05
17,0	465	6	43	5,4
22,5	810	10	60	3,15
27,0	1200	16	80	2,05
32,0	1750	25	101	1,35
36,0	2300	35	126	0,98
41,5	3100	50	153	0,71
47,0	4200	70	196	0,52



Société Internationale de Produits et services Industriels

102 rue J.-B. Charcot

92400 Courbevoie - France

☎ : (33^e) 01 47 68 75 00

✉ : ipsi@ipsifrance.com

☎ : (33) 01 47 89 99 39

🌐 : www.ipsifrance.com

Y-SHAPED JUNCTION BOX WITH RESIN FILLING



Universal use for branching cables with synthetic insulation or conductors with PVC, PE, VPE, and EPR insulation (e.g. N(A)YY, NYM, TT) with or without concentric conductors. Suited for copper and aluminum cables.

Voltage level

- $U_o/U (U_m)$ 0.6/1 (1.2) kV

Applications

- Indoor installations
- Overhead lines
- Buried lines
- Water
- Installation channels

Tested to

- DIN VDE 0278 Part 1 and 3
- DIN VDE 0278 Part 393
- EN 50393 as well as CENELEC HD 623 (VDE 0278 Part 623)

Characteristics

- Large opening for easy resin pouring
- High electrical insulation
- Absolute tightness both in the longitudinal and transversal direction
- High mechanical strength
- Good resistance to UV radiation, alkaline earths, and chemicals
- Compact dimensions
- Storage life of resin up to 40 months as standard
- High quality shells
- Visibility of connection before casting
- Easy and fast implementation, hence time and cost saving
- Immediately operational

Indication

- From the Y3 size upward, it is possible to use a live line connector (for example branching terminals HE 1/70/150)
- With adequate accessories, the Y-shaped junction boxes can be used for paper-insulated cables (only upon request).

Scope of supply

- Clear polycarbonate self-sealing shells
- Hydrolysis-resistant PUR resin type EG packed in a convenient dual bag containing the required volume ready for use
- Filling funnel
- Air vent funnel (except Y 00)
- Caps
- Insulating tape
- Gloves
- Illustrated, easy-to-read instructions leaflet

Type	L mm	D mm	H mm	B mm	Max. cable dia. mm		Cable with synthetic insulation				Concentric shield			
							3x		4x		5x		3x	
							Main cable	Branch cable	Main cable	Branch cable	Main cable	Branch cable	Main cable	Branch cable
Max. conductor gage in mm ²														
Y0	185	45	55	80	17	17	4	4	4	4	4/4	4/4		
Y1	240	60	70	110	22	22	6	10	10	6	10/10	10/10		
Y2	285	65	75	120	37	33	16	16	16	16	16/16	16/16		
Y3	240	100	110	145	42	37	25	50	35	25	25/25	25/25		
Y3.5	300	110	120	150	54	38		50	35	35	35/35	25/25		
Y4	285	110	120	170	53	37		95	50	50	70/70	25/25		
Y4.5	335	120	130	193	56	42		150	70		120/120	95/95		
Y5	382	140	150	220	62	52		240	95		150/150	95/95		
Y6	570	180	190	275	90	80		300	185		240/120	185/95		



Société Internationale de Produits et services Industriels

102 rue J.-B. Charcot
92400 Courbevoie - France
☎ : (33) 01 47 68 75 00
✉ : ipsi@ipsifrance.com

☎ : (33) 01 47 89 99 39
🌐 : www.ipsifrance.com

Type	L mm	D mm	H mm	B mm
Y0	185	45	55	80
Y1	240	60	70	110
Y2	285	65	75	120
Y3	240	100	110	145
Y3.5	300	110	120	150
Y4	285	110	120	170
Y4.5	335	120	130	193
Y5	382	140	150	220
Y6	570	180	190	275

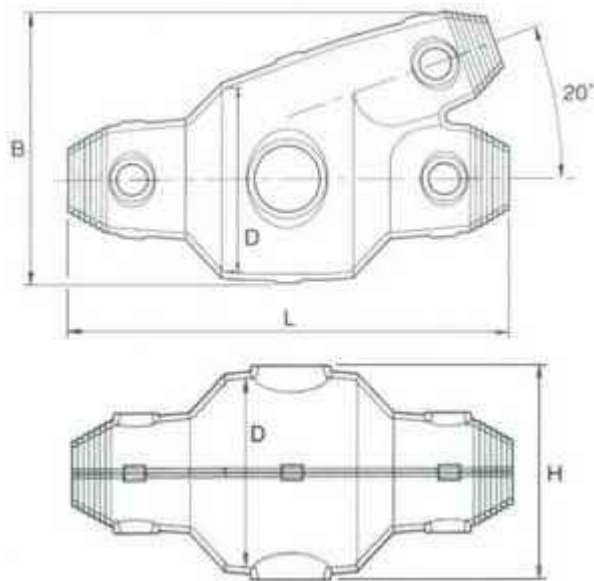
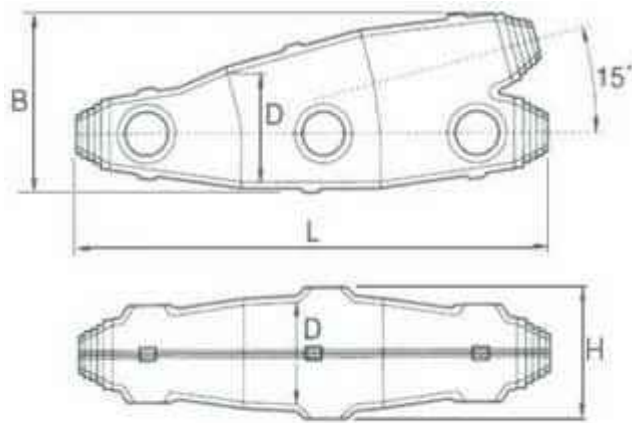

Y 3, Y 4, Y 4 1/2



Société Internationale de Produits et services Industriels

102 rue J.-B. Charcot
92400 Courbevoie - France
☎ : (33) 01 47 68 75 00
✉ : ipsi@ipsifrance.com

☎ : (33) 01 47 89 99 39
🌐 : www.ipsifrance.com

JUNCTION BOX WITH RESIN FILLING



Universal use for connecting cables with synthetic insulation or conductors with PVC, PE, VPE, and EPR insulation (e.g. N(A)YY, NYM, TT) with or without concentric conductors. Suited for copper and aluminum cables.

Characteristics

- Compact size
- Visibility of connection before casting
- High quality, impact-resistant clear plastic shells
- Immediately operational
- Easy and fast implementation, hence time and cost saving
- Large opening for easy resin pouring
- Good resistance to chemicals
- Resistant to alkaline earths
- Resistant to UV radiation
- Longitudinal and transversal tightness
- High electrical insulation
- High mechanical strength

Applications

- Indoor installations
- Outdoor installation
- Buried lines
- Water
- Installation channels

Voltage level

- U_0/U (Um) 0.6/1 (1.2) kV

Scope of supply

- Cover
- Hydrolysis-resistant PUR resin type EG premixed and measured, packed in two bags, convenient and easy to use
- Clear polycarbonate self-sealing shells
- Spacers
- Mountings instructions
- PVC insulating tape
- Protective glove

Indication





- Without connectors

Tested to

- DIN VDE 0278 Part 1 and 3
- DIN VDE 0278 Part 393
- EN 50393 as well as CENELEC HD 623 (VDE 0278 Part 623)

Storage conditions/Shelf life

- Casting resin up to 40 months

Type	Max. cable dia. mm	L mm	D m	H mm	Cable with synthetic insulation		Concentric shield	Armored cables
								
					4x	5x	3x	4x
					Max. conductor gage in mm ²			
M11	26	190	36	50	10	6	10/10	4
M12	34	260	47	63	25	16	25/25	10
M13S	43	310	55	68	35	25	35/35	25
M13	43	360	55	75	50	35	50/50	35
M14S	48	350	70	95	70	50	70/70	50
M14	48	400	70	95	95	70	95/95	70
M15	63	530	100	120	150	120	150/150	120
M16	81	700	125	160	240	185	240/120	240

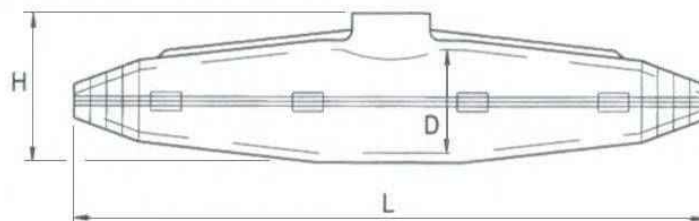

Société Internationale de Produits et services Industriels

102 rue J.-B. Charcot
92400 Courbevoie - France
☎ : (33) 01 47 68 75 00
✉ : ipsi@ipsifrance.com

☎ : (33) 01 47 89 99 39
🌐 : www.ipsifrance.com

CLAW CONNECTORS

Claw connectors, tinned
(hot swaged brass, steel screws and nuts)

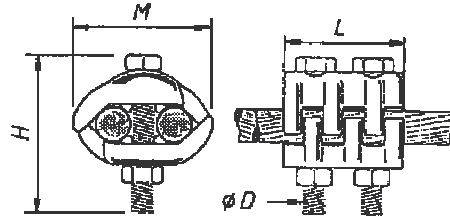

Part number Steel clamp	Min.- max. gage mm ²	Bolts No. x dia. D	Dimensions			Packaging unit
			mm			
RG 4 - 30	4 - 30	1 x 6	20	25	25	Box of 25
RG 10 - 50	10 - 50	1 x 6	23	30	25	Box of 25
RG 10 - 50 / 2	10 - 50	2 x 6	30	30	25	Box of 25
RG 16 - 95	16 - 95	2 x 6	30	37	10	Box of 10
RG 25 - 150	25 - 150	2 x 8	42	48	10	Box of 10



Société Internationale de Produits et services Industriels

102 rue J.-B. Charcot
92400 Courbevoie - France

☎ : (33^e) 01 47 68 75 00
✉ : ipsi@ipsifrance.com

☎ : (33) 01 47 89 99 39
🌐 : www.ipsifrance.com

C-SHAPED BRANCHING CONNECTOR

Material : electrolytic copper
Surface tinned by electrolysis

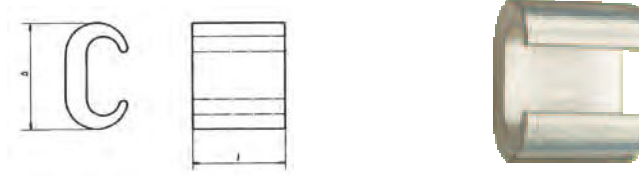

Part number	Gage in mm ²		Dimensions in mm		Packaging unit
	Main conductor	Branch conductor	b	l	
CK 16	16/25	16/25	16	15	Box of 100
CK 25	25/35	25/35	25	23	
CK 35	35/50	35/50	26	20	
CK 50	50/-	50/-	26	20	
CK 70	70/-	70/-	34	28	
CK 95	95/-	95/-	41	30	
CK 120	120/-	120/-	60	40	



Société Internationale de Produits et services Industriels

102 rue J.-B. Charcot

92400 Courbevoie - France

☎ : (33) 01 47 68 75 00

✉ : ipsi@ipsifrance.com

☎ : (33) 01 47 89 99 39

🌐 : www.ipsifrance.com

SLEEVES WITH INNER STOP

Material : tube made of el. copper
Surface tinned by electrolysis

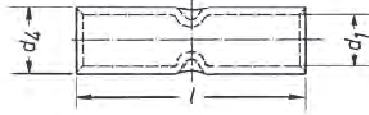

Part Number	Gage mm ²	Dimensions in mm			Packaging unit
		d1	d4	l	
MNF 1,5	1,5	1,7	3,3	20	Box of 100
MNF 2,5	2,5	2,2	4	20	
MNF 4	4	2,7	5	25	
MNF 6	6	3,3	5,5	26	
MNF 10	10	4,2	6,8	28	
MNF 16	16	5,5	8	32	
MNF 25	25	6,6	9,5	36	
MNF 35	35	7,9	11	38	
MNF 50	50	9,2	12,5	46	
MNF 70	70	11	15	50	
MNF 95	95	13,1	17	57	
MNF 120	120	14,5	19	61	



Société Internationale de Produits et services Industriels

102 rue J.-B. Charcot
92400 Courbevoie - France

☎ : (33) 01 47 68 75 00
✉ : ipsi@ipsifrance.com

☎ : (33) 01 47 89 99 39
🌐 : www.ipsifrance.com

TUBULAR CABLE LUGS

Material: lug tube made of el. copper
 Surface tinned by electrolysis
 Standard: with inspection and flaring hole

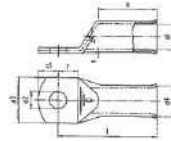

Part number	Gage mm ²	Bore dia.	Dimensions in mm									Packaging unit
			d1	d4	d3	d2	a	r	c1	e	l	
CNF 1,5 - 2	1,5	M 2	1,7	3,3	6	2,3	6	4	3,25	0,5	12	Box of 100
CNF 1,5 - 3		M 3			6	3,2		4	3,25		12	
CNF 1,5 - 4		M 4			7,5	4,3		5	4		13	
CNF 1,5 - 5		M 5			8	5,3		5,5	4,75		14	
CNF 1,5 - 6		M 6			9	6,5		6,5	6,5		16	
CNF 2,5 - 3	2,5	M 3	2,2	4	8	3,2	6	4	3,25	0,5	12	Box of 100
CNF 2,5 - 4		M 4			8	4,3		5	4,5		13	
CNF 2,5 - 5		M 5			8	5,3		5,5	5		14	
CNF 2,5 - 6		M 6			10	6,5		6,5	6,5		16	
CNF 2,5 - 8		M 8			12	8,5		9,5	7,75		20	
CNF 4 - 4	4	M 4	2,7	5	9	4,3	8	5,5	4,75	1	17	Box of 100
CNF 4 - 5		M 5			9	5,3		6	4,75		17	
CNF 4 - 6		M 6			12	6,5		6,5	6,5		19	
CNF 4 - 8		M 8			12	8,5		9,5	8,5		22	
CNF 6 - 4	6	M 4	3,3	5,5	13	4,3	11	7,5	6,5	1	24	Box of 100
CNF 6 - 5		M 5			13	5,3		7,5	6,5		24	
CNF 6 - 6		M 6			13	6,5		8	7,5		25	
CNF 6 - 8		M 8			13	8,5		10	10		28	
CNF 6 - 10		M 10			16	10,5		12	12		30	
CNF 10 - 4	10	M 4	4,2	6,8	12	4,3	12	7,5	6,5	1	24	Box of 100
CNF 10 - 5		M 5			12	5,3		7,5	6,5		24	
CNF 10 - 6		M 6			12	6,5		7,5	6,5		24	
CNF 10 - 8		M 8			15	8,5		10	10		27	
CNF 10 - 10		M 10			16	10,5		12	12		29	
CNF 10 - 12		M 12			19	13		13	13		31	
CNF 16 - 5	16	M 5	5,5	8	12	5,3	14	7,5	6,25	1	27	Box of 100
CNF 16 - 6		M 6			12	6,5		7,5	6,25		27	
CNF 16 - 8		M 8			16	8,5		9,5	8,5		29	
CNF 16 - 10		M 10			16	10,5		11,5	10,5		31	
CNF 16 - 12		M 12			19	13		13	12		32	
CNF 25 - 5	25	M 5	6,6	9,5	13	5,3	15	7,5	6,25	1	30	Box of 100
CNF 25 - 6		M 6			13	6,5		7,5	6,25		30	
CNF 25 - 8		M 8			16	8,5		10	10		32	
CNF 25 - 10		M 10			17	10,5		12	12		34	
CNF 25 - 12		M 12			19	13		13	13		35	
CNF 25 - 14		M 14			21	15		14,5	14,5		38	
CNF 35 - 5	35	M 5	7,9	11	15	5,3	17	7,5	7,5	1	32	Box of 100
CNF 35 - 6		M 6			15	6,5		7,5	7,5		32	
CNF 35 - 8		M 8			17	8,5		10	10		34	
CNF 35 - 10		M 10			17	10,5		12	12		37	
CNF 35 - 12		M 12			19	13		13	13		38	
CNF 35 - 14		M 14			21	15		14,5	14,5		39	



Société Internationale de Produits et services Industriels

102 rue J.-B. Charcot
 92400 Courbevoie - France
 ☎ : (33) 01 47 68 75 00
 ✉ : ipsi@ipsifrance.com

☎ : (33) 01 47 89 99 39
 🌐 : www.ipsifrance.com

Part number	Gage mm ²	Bore dia.	Dimensions in mm									Packaging unit
			d1	d4	d3	d2	a	r	c1	e	l	
CNF 50 - 6	50	M 6	9,2	12,5	17	6,5	19	7,5	7,5	1	35	Box of 100
CNF 50 - 8		M 8			18	8,5		10	10		37	
CNF 50 - 10		M 10			18	10,5		12	12		40	
CNF 50 - 12		M 12			19	13		13	13		41	
CNF 50 - 14		M 14			21	15		14,5	14,5		43	
CNF 50 - 16		M 16			26	17		16	16		45	
CNF 70 - 6	70	M 6	11	15	21	6,5	21	10	10	2	41	Box of 100
CNF 70 - 8		M 8			21	8,5		10	10		41	
CNF 70 - 10		M 10			21	10,5		12	12		43	
CNF 70 - 12		M 12			21	13		13	13		46	
CNF 70 - 14		M 14			23	15		14,5	14,5		48	
CNF 70 - 16		M 16			28	17		16	16		50	
CNF 70 - 20		M 20			30	21		19	19		53	
CNF 95 - 6	95	M 6	13,1	17	23	6,5	25	10	10	2	46	Box of 100
CNF 95 - 8		M 8			23	8,5		10	10		46	
CNF 95 - 10		M 10			23	10,5		12	12		48	
CNF 95 - 12		M 12			23	13		13	13		50	
CNF 95 - 14		M 14			23	15		14,5	14,5		52	
CNF 95 - 16		M 16			25	17		16	16		54	
CNF 95 - 20		M 20			30	21		19	19		57	



Société Internationale de Produits et services Industriels

102 rue J.-B. Charcot
92400 Courbevoie - France

☎ : (33) 01 47 68 75 00
✉ : ipsi@ipsifrance.com

☎ : (33) 01 47 89 99 39
🌐 : www.ipsifrance.com

ELECTRICAL INSTALLATION TAPE

- ✓ Outstanding reliability of Scotch® electrical tapes,
- ✓ Suitable for all low voltage and high voltage insulation applications,
- ✓ Expertise of the world's leading manufacturer of adhesive tapes.

Electrical insulating tape

Electrical insulation : low voltage

Mechanical protection

Protection against moisture and chemicals (acids, bases).

Scotch® Super 33+ vinyl tape

Description : High performance electrical tape coated with a powerful pressure-sensitive adhesive. Its thickness of 0.18 mm ensures an excellent flexibility.

Application : Indoor and outdoor uses: restoration of LV or HV cable sheaths, compatible with the synthetic insulation of cables, with elastomers (Scotchfil-Scotch® 23), and with epoxy and polyurethane resins. Insulation and protection of cables and splices.

Characteristics : Outstanding mechanical strength and flexibility allowing uses from -18°C up to $+60^{\circ}\text{C}$. It is designed to maintain its performance in extreme ambient temperature conditions of from -40 to $+105^{\circ}\text{C}$. Resistant to UV radiation, acids, alkalis. Self-extinguishing and weather-resistant. Flame-retardant.



Scotch® 22 vinyl tape

Description : Tape substrate made of black, flexible insulating vinyl coated with a non-corrosive adhesive. Its thickness of 0,25 mm ensures excellent mechanical properties.

Application : Indoor and outdoor uses: insulation or protection of cable sheaths, various divers electrical connections: transformer conductors, circuit breaker connections, bus bars. Jacketing of cables.

Characteristics : Outstanding mechanical strength. Flexibility. Flame-retardant. Excellent resistance to various aggressive media (abrasion, weather, molds, alkalis, UV). Class Y (80°C).



Self-fusing tapes

Most of these tapes can be used for LV and HVA applications up to 69 kV (junctions, branches and terminations).

Moisture-resistant.

Self-fusing.

Application temperature 90°C permanent, 130°C peak.

Scotch® 23 elastomeric insulating tape

Description : Black elastomeric electrical insulating tape based on EPR (Ethylene Propylene Rubber), thickness 0.75 mm, with liner.

Application: Restoration of cable insulation up to 69 kV.

Jacketing : In combination with Scotch 24 tinned copper open-weave knit tape for solder replacement. Making of sealing plugs around various cables and ducts.

Characteristics : Self-fusing: the tape layers fuse into a homogeneous mass after application. Outstanding ozone resistance. Compatible with all cables with synthetic insulation and cables with paper insulation impregnated with a non-migrating material. The tape is halogen-free.



Société Internationale de Produits et services Industriels

102 rue J.-B. Charcot

92400 Courbevoie - France

☎ : (33) 01 47 68 75 00

✉ : ipsi@ipsifrance.com

☎ : (33) 01 47 89 99 39

🌐 : www.ipsifrance.com

Sealing or protection tape

Sealing. Electrical insulation up to 600 V.

Scotchfil™ elastomer tape

Description : Electrical insulation putty, non-corrosive synthetic rubber-based tape with projecting white liner. Its overall thickness is 3 mm.

Application : Covering of sharp angles of cable lugs and connections. Restoration of LV cable insulation. Sealing. Repair of cable jackets. Suppression of irregularities. Insulation of low voltage electrical terminals.

Characteristics : Instantaneous self-fusing into a solid, homogeneous mass around all sorts of shapes, even irregular one. Highly flexible and plastic: the Scotchfil™ tape exhibits outstanding electrical properties, as well as a very good aging behavior. It does not harden, craze, or get moldy. Compatible with all cable jacket insulation types. Temperature range of from -20 °C to +80 °C.



Société Internationale de Produits et services Industriels

102 rue J.-B. Charcot
92400 Courbevoie - France

☎ : (33) 01 47 68 75 00
✉ : ipsi@ipsifrance.com

☎ : (33) 01 47 89 99 39
🌐 : www.ipsifrance.com

HANDY CAPS

The Handy Cap™ is a prefabricated assembly 102 x 102 mm in size, designed for the cathodic protection of pipe and tank connections. Pressed by hand in position over the anode wire weld, it forms a thick, highly resistant electrically insulating seal over the weld, the connecting wire end and the surrounding area of the pipe or tank surface.

The Handy Cap is easy to use and cost-effective. It can be used on all anode and test wire connection welds. It is particularly useful for welds on factory-coated pipes, where only a small part of the coating was removed to allow aluminothermic welds for grounding/earthing purposes. It is ideally suited for applications where access is limited as it is easy to handle and simple to apply.

Description :

- ✓ Plastic covering sheet with an igloo-shaped dome and an input tunnel for the connecting wire.
- ✓ The special elastomeric compound comprising the plastic dome is strong enough to withstand all normal application and operating temperatures, yet flexible enough to closely fit and fully cover the irregular welded profile.
- ✓ On each side of the dome, the cap features a double row of parallel serrations that ensure the required flexibility to fit onto small diameter pipes.
- ✓ Base of Royston Tac-Tape, a black elastomeric tape, without reinforcement, having outstanding adhesive properties that ensure a solid bond with the metal surface.

Typical properties :

- ✓ Construction : molded plastic dome filled with a corrosion-resistant compound based on a thick elastomeric tape.
- ✓ Overall dimensions : 102 x 102 mm.
- ✓ Plastic sheet : 70 x 102 mm (serrated).
- ✓ Sheet thickness : 0.25 mm.
- ✓ Plastic dome : dia. 41,3 mm / height 20.3 mm.
- ✓ Adhesive thickness : 4.2 mm.
- ✓ Weight : 59.5 g.
- ✓ Application temperature : -29 °C to 49 °C.
- ✓ Temperature of service : -40 °C to + 85 °C.
- ✓ Shelf life : ensure an annual turnover.

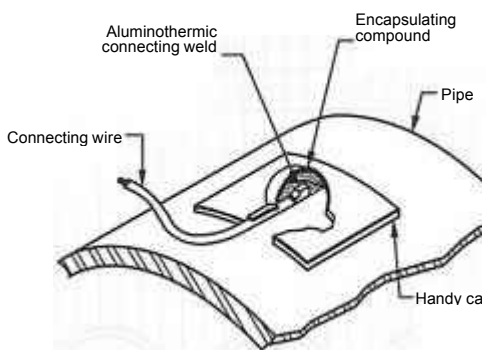

Société Internationale de Produits et services Industriels

102 rue J.-B. Charcot

92400 Courbevoie - France

☎ : (33) 01 47 68 75 00

✉ : ipsi@ipsifrance.com

☎ : (33) 01 47 89 99 39

🌐 : www.ipsifrance.com

JANOFLEX – TPC N

Protective duct systems for cables and/or buried electrical lines per NF EN 50086-2-4+A1

European standards :

NF EN 50086-2-4+A1

Colors :

- Yellow : for gas.
- Blue : for water.
- Green : for telecommunication.
- Red : for electricity.
- Orange and white : for fiber optics.

Packaging unit :

25-m coil, duct diameter 50 mm.

Technical data :

- Material : Polyethylene.
- Connection : All our Janoflex® ducts are fitted with serrated sleeves.
- Resistance values :
 - Impact: testing at -5°C , 5 kg mass, striker : dia. 20 mm, radius 300 m
 - Collapsing: a minimum force of 450 N is required to cause a 5% deformation of the inner diameter.

Temperature :

- Storage and transport : min. -25°C .
- Laying : min. -15°C .
- Operation, permanent : 60°C .
- Protection index : min. IP30.



Société Internationale de Produits et services Industriels

102 rue J.-B. Charcot
92400 Courbevoie - France

☎ : (33) 01 47 68 75 00
✉ : ipsi@ipsifrance.com

☎ : (33) 01 47 89 99 39
🌐 : www.ipsifrance.com

WARNING MESH

Application :

Used to warn of the presence of a buried structure, to identify its nature, and to indicate its orientation.

Warning device :

A warning device of the plastic mesh type must be placed over each pipe or duct.

This warning device should be located 0.20 m above the pipe or duct.

It must have the same color as the pipe or duct exemple : RED for electrical ducts.

Characteristics :

- Material : polyolefins.
- Colors : red, green, yellow, blue, orange, white, brown.
- Very high mechanical strength due to the very wide mesh interleaving.
- Inalterable dope dyeing.
- Free from natural corrosion.

Packaging unit :

- Length : 100-m coil.
- Width : 0.30 m.
- Detectable mesh upon request.
- Sold by unit or in pallets/cartons of 72 coils



Société Internationale de Produits et services Industriels

102 rue J.-B. Charcot
92400 Courbevoie - France

☎ : (33) 01 47 68 75 00
✉ : ipsi@ipsifrance.com

☎ : (33) 01 47 89 99 39
🌐 : www.ipsifrance.com